

# Preparation and properties of TiC micro-coils and micro-tubes by the vapour phase titanizing of carbon micro-coils

SEIJI MOTOJIMA

Department of Applied Chemistry, Faculty of Engineering, Gifu University,  
Gifu 501-1193, Japan  
E-mail: [motojima@apchem.gifu-u.ac.jp](mailto:motojima@apchem.gifu-u.ac.jp)

SHAOMING YANG, XIUQIN CHEN

Faculty of Chemical Engineering, Huaqiao University, Quanzhou, Fujian 362011,  
People's Republic of China

HIROSHI IWANAGA

Department of Materials Science, Faculty of Engineering, Nagasaki University,  
Nagasaki 852-8521, Japan

TiC micro-coils and micro-tubes were prepared by the vapour phase titanizing of the regular carbon micro-coils, and the preparation conditions and some properties were examined. The carbon coils were titanized from the surface of the fiber to the core with full preservation of the coiling morphology to form TiC micro-coils or micro-tubes. The bulk electrical resistivity was 0.1–0.01  $\Omega\cdot\text{cm}$  depending on the titanized rate and the bulk density. The specific surface area of the source carbon coils (about 100  $\text{m}^2/\text{g}$ ) was significantly decreased with increasing reaction temperature and reaction time. The tensile strength of a TiC micro-tube was 660 MPa. The attenuation ratio against an electromagnetic wave of the TiC micro-tubes (30 wt% in epoxy resin) was about 90% ( $\text{dB} = -10$ ) for 800–900 MHz. © 1999 Kluwer Academic Publishers

## 1. Introduction

Materials with various morphologies or structures, such as fine powders, thin films, straight thin fibers, lumps, etc. are widely used in industry. However, materials with a three-dimensional (3D) micro-helical or micro-coiled structure, or with a micro-pipe or tube morphology are not observed among the industrially available materials. For example, carbon fibers, which are now widely used as a reinforcement for composite materials, are always straight fibers. On the other hand, the helical morphology of  $\alpha$ -proteins or DNA provides living bodies with essential and critical functional roles. Accordingly, we could expect novel properties from such micro-coiled materials which have morphologies similar to DNA.

Davis *et al.* first reported the vapor growth of thin carbon fibers twisted together in the form of a rope [1]. The growth of micro-coiled carbon fibers from the vapour phase were then reported by many researchers [2–9]. The vapor growth of micro-coils of SiC [10–12],  $\text{Si}_3\text{N}_4$  [13–16], etc. were also reported. However, the growth of such coiled fibers was extremely accidental and poorly reproducible. We have found that regular micro-coiled carbon fibers (referred to as “carbon coils” hereafter) could be obtained with high reproducibility by the catalytic pyrolysis of acetylene [17–26]. Furthermore, we have vapour phase metallized the carbon coils with

full preservation of the coiling morphology, forming micro-coils of SiC [27], TiC [19, 27], and ZrC [28]. However, their structure and properties were not examined in detail. The micro-coiled fibers or micro-tubes of metal carbides may be potential candidates for conductive fillers, reinforcing fibers, electromagnetic shielding materials or absorbers, microsensors, etc.

In this study, very regular carbon coils obtained by the Ni-catalyzed pyrolysis of acetylene were vapour-phase titanized to form regular TiC micro-coils, TiC/C-composite micro-coils, and micro-tubes, and the reaction conditions and some properties were examined in detail.

## 2. Experiments

The source regular carbon coils were prepared by the Ni-catalyzed pyrolysis of acetylene containing a small amount of thiophene as an impurity. The detailed preparation procedures and conditions are shown in reference [21]. The used carbon coils have a very regular coil diameter of 3–5  $\mu\text{m}$ , coil pitch of 0.3–2  $\mu\text{m}$  and coil length of 1–5 mm. The apparatus used for titanizing the carbon coils is shown in Fig. 1. The source carbon coils were located in the horizontal rotating reaction tube (quartz, 25 mm i.d.), and titanized under a  $\text{TiCl}_4 + \text{H}_2$  atmosphere at 900–1200 °C. Gas flow rates of  $\text{TiCl}_4$

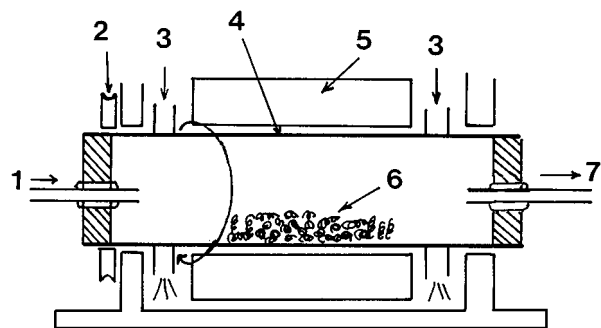

Figure 1 Apparatus: 1)  $\text{TiCl}_4 + \text{H}_2$  gas inlet; 2) rotation belt; 3) cooling water; 4) reaction tube (quartz, 25 mm i.d.); 5) heater; 6) sample; 7) gas outlet.

and  $\text{H}_2$  were fixed at 10 sccm (standard  $\text{cm}^3/\text{min}$ ) and 100 sccm, respectively.

### 3. Results and discussion

#### 3.1. Titanizing conditions and morphology

The carbon coils could be titanized from the surface to the core with full preservation of the regular coiling morphology at a rate according to the square root law in relation to the reaction time in the temperature ranges of 900–1200 °C. This suggests that the rate-determining step is the diffusion of Ti or carbon through the deposited TiC layers. The surface morphology of the obtained TiC coils are shown in Fig. 2. The size of TiC

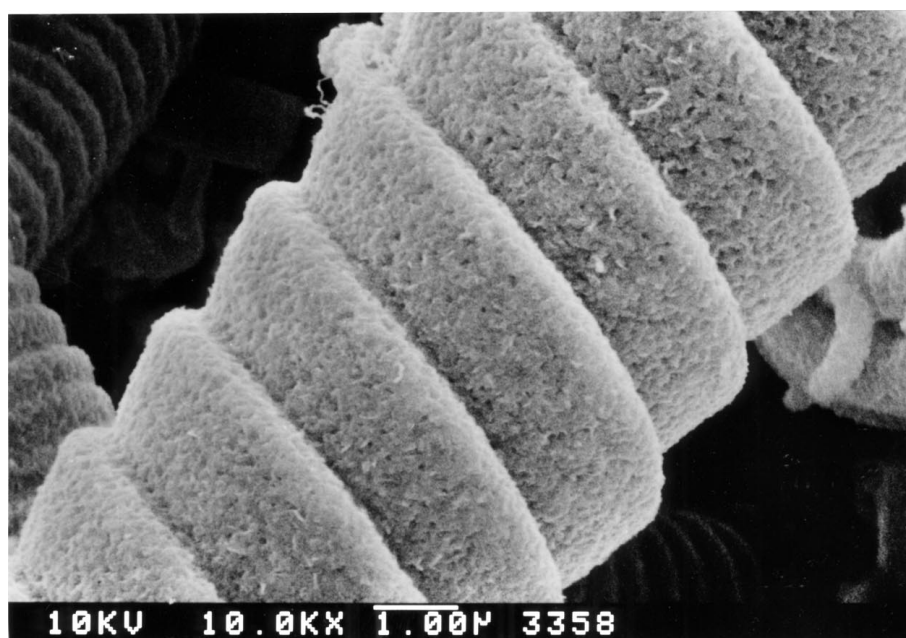

(a)

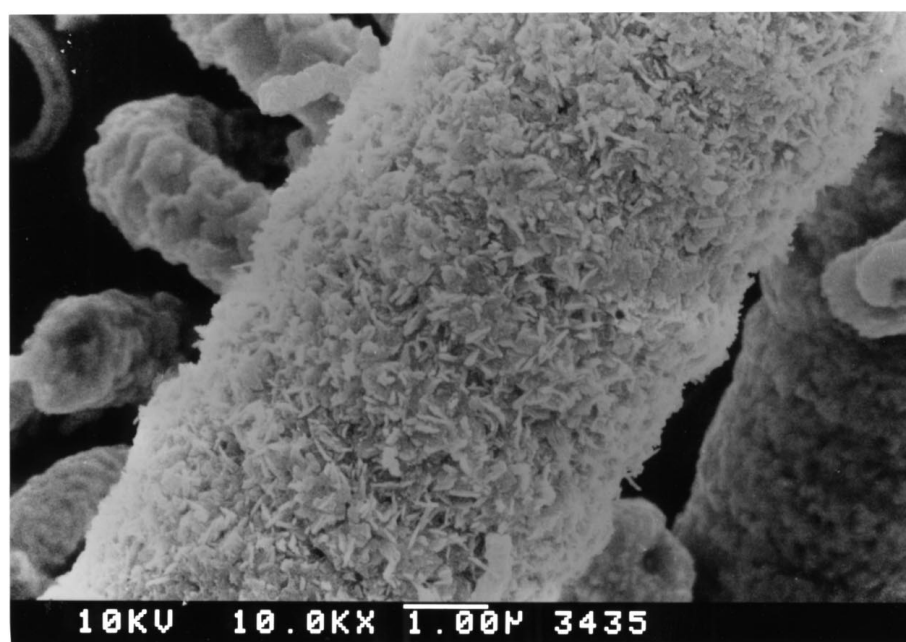

(b)

Figure 2 Surface of the titanized carbon coils. Reaction temperature: 1200 °C, reaction time: (a) 1 h; (b) 3 h.

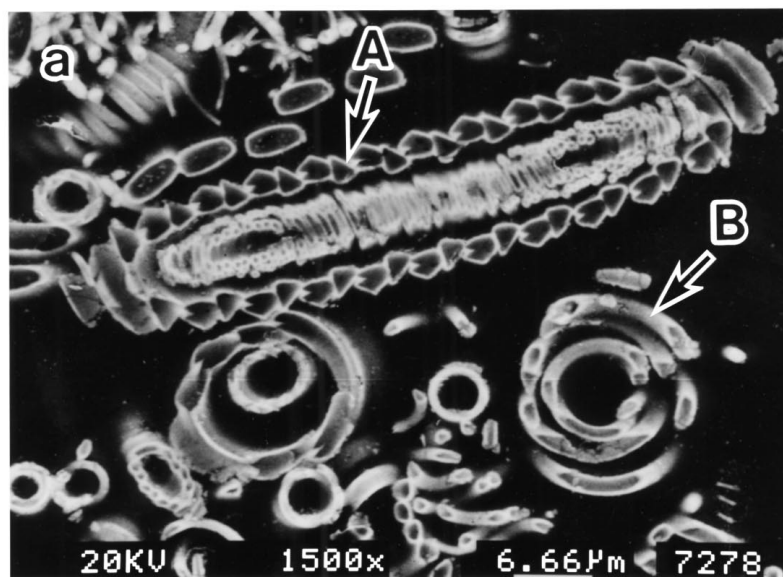

(a)

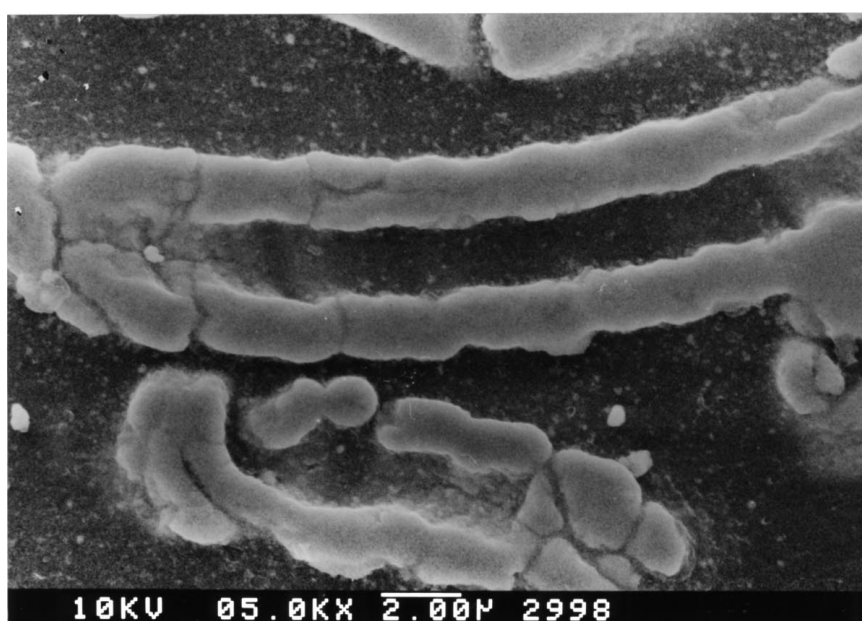

(b)

Figure 3 Polished cross section of the TiC micro-coils. Reaction temperature: 1200 °C, reaction time: (a) 0.25 h; (b) 3 h. (A) Horizontal cross section against the coil axis, (B) vertical cross section.

grains increased with increasing reaction time, and the coiling pattern gradually disappeared with increasing reaction time and then completely disappeared after 3 h as shown in Fig. 2b. The polished cross sections of the TiC coils obtained at different reaction times are shown in Fig. 3. It can be seen in Fig. 3a that uniform thin TiC layers were formed on the surface of the fibers, in which the white part is the formed TiC layer and the black part enclosed by the white part is the unreacted carbon coil. Both horizontal (arrow, A) and vertical (arrow, B) cross sections against the coil axis can be seen in the same micrograph. The thickness of the TiC layers increased with increasing reaction time. The carbon fibers were titanized to the core after a 3 h reaction time and the formed TiC layers coalesced with each other to form the microtubes as shown in Fig. 3b. Presence of Ti was identified in the white part by the electron probe

microanalysis (EPMA) on the vertical cross section of the TiC coils. X-ray diffraction analysis of the TiC coils obtained at different reaction times are shown in Fig. 4. The source carbon coils is almost amorphous as shown in Fig. 4a. Apparent TiC peaks can be seen after a 0.5 h reaction time, and the peaks become higher and sharper with increasing reaction time.

### 3.2. Properties

The bulk electrical resistivity was measured using a 10 mm i.d. cylindrical measurement glass cell at room temperature. The bulk electrical resistivity of the TiC coils with different Ti/C ratios are shown in Fig. 5 in relation to the bulk density. The Ti/C ratio of the TiC coils was obtained from the weight gain by the titanizing. The source carbon coils have a bulk electrical resistivity of

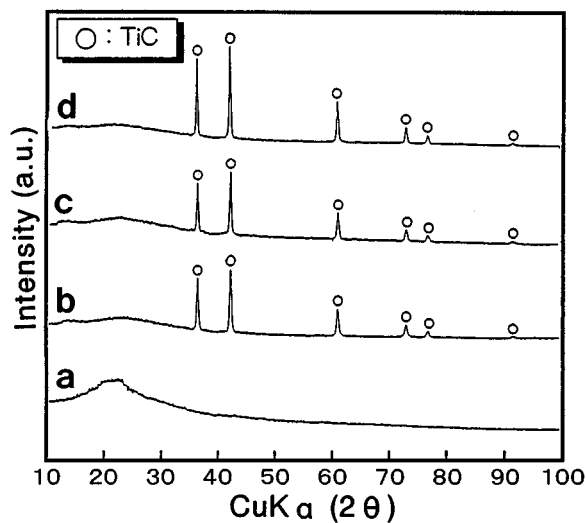

Figure 4 X-ray diffraction profiles: (a) As-grown carbon coils, reaction time; (b) 0.5 h; (c) 1 hr; (d) 2 h.

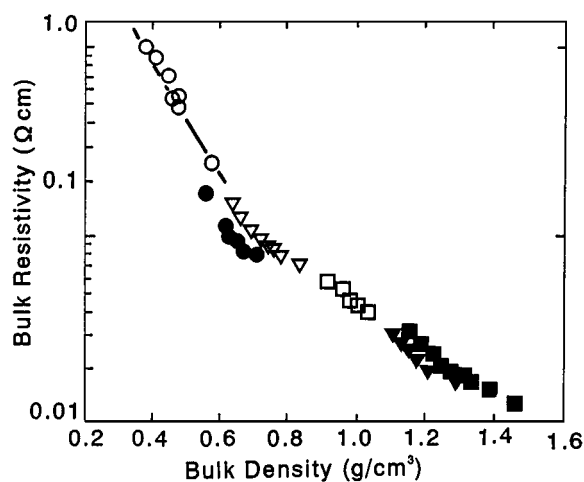

Figure 5 Effect of bulk density on the bulk electrical resistivity (1). (○) As-grown carbon coils, Ti/C ratio in the TiC micro-coils or tubes: (●) 0.15; (▽) 0.42; (□) 0.58; (▼) 0.82; (■) 1.0.

0.9–0.1  $\Omega\cdot\text{cm}$  for a bulk density of 0.4–0.6  $\text{g}/\text{cm}^3$ . The bulk electrical resistivity of the TiC coils decreased with increasing Ti/C ratio and also with increasing bulk density. The effects of the TiC coil length on the electrical resistivity is shown in Fig. 6, and compared with samples of the TiC fine powder. The electrical resistivity of the TiC micro-coils and micro-pipes increased with decreasing length and increasing bulk density. The fine TiC powder (0.83  $\mu\text{m}$ ) shows a higher resistivity than that of fine TiC coils (0–30  $\mu\text{m}$  coil length). This may be caused by the oxide layers formed on the surface of the TiC layers as shown in the case of ZrC coils [28].

The specific surface area of the TiC micro-coils and micro-tubes were measured using the BET method, and the results are shown in Fig. 7. The large specific surface area of the source carbon coils (100  $\text{m}^2/\text{g}$ ) was significantly decreased with increasing reaction time and decreased to a few  $\text{m}^2/\text{g}$  for the TiC micro-tubes obtained at 1200  $^\circ\text{C}$  for 2 h. The source carbon coil has many micropores on the surface, and the pore may be sealed by the deposited TiC layers.

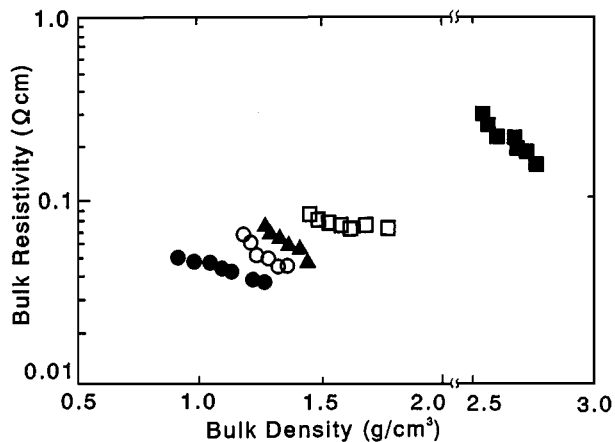

Figure 6 Effect of bulk density on the bulk electrical resistivity (2). Coil length: (▲) 0–30  $\mu\text{m}$ ; (○) 30–50  $\mu\text{m}$ ; (●) 50–300  $\mu\text{m}$ ; (■) TiC powders (0.89  $\mu\text{m}$  diam.); (□) TiC powders (20  $\mu\text{m}$  diam.).

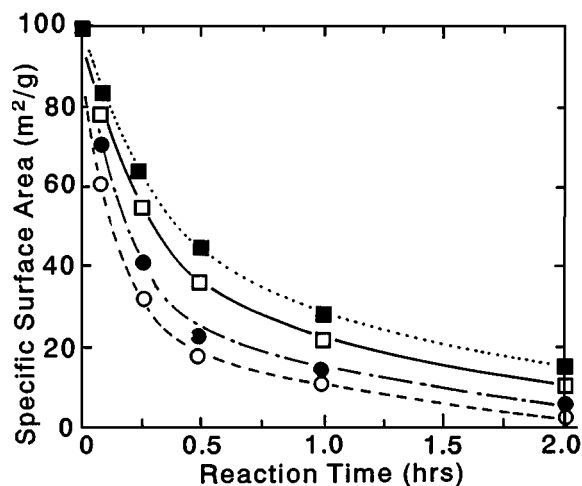

Figure 7 Effect of reaction time on the specific surface area. Reaction time: (■) 900  $^\circ\text{C}$ ; (□) 1000  $^\circ\text{C}$ ; (●) 1100  $^\circ\text{C}$ ; (○) 1200  $^\circ\text{C}$ .

The tensile strength of the TiC micro-tubes was measured using the novel method developed by Iwanaga *et al.* [29]. The averaged tensile strength of the TiC tubes (Ti/C = 1) was 660 MPa. The ruptured cross section of a TiC micro-pipe after the tensile strength measurement is shown in Fig. 8. The TiC micro-tube is almost vertically ruptured against the tube axis.

The attenuation ratio (dB) against the electromagnetic (EM) wave of the TiC tubes was measured using an RF Field Analyzer (ADVANTEST, U4941) in the MHz region. The TiC micro-tubes were mixed with epoxy resin and molded to form the measurement disk (30 mm diameter, 3 mm thick). The obtained result indicates the sum of the absorption and reflection losses of the irradiated EM wave through the sample. The attenuation ratio of the TiC tubes against an EM wave is shown in Fig. 9. The TiC powder or source carbon coils did not attenuate the irradiated EM wave. On the other hand, the 300  $\mu\text{m}$  long TiC micro-tubes attenuated about 90% (dB = -10) of the introduced EM wave in the 800–900 MHz region. The reason for this effect is not yet known.

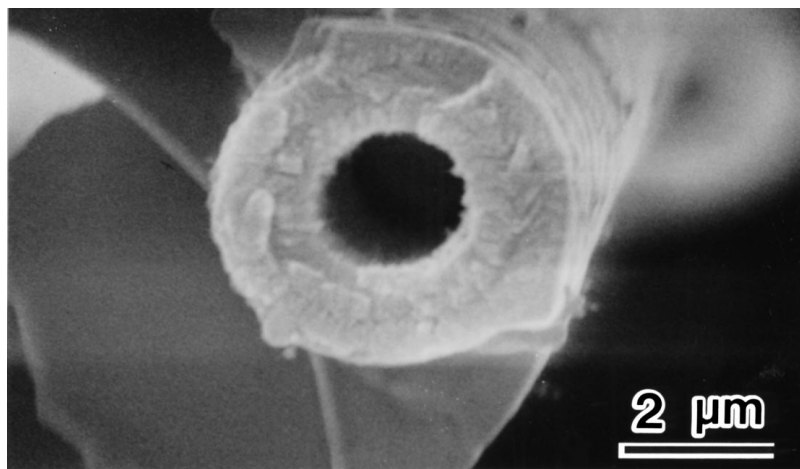

Figure 8 Ruptured cross section of a TiC micro-tube after the tensile strength measurement.

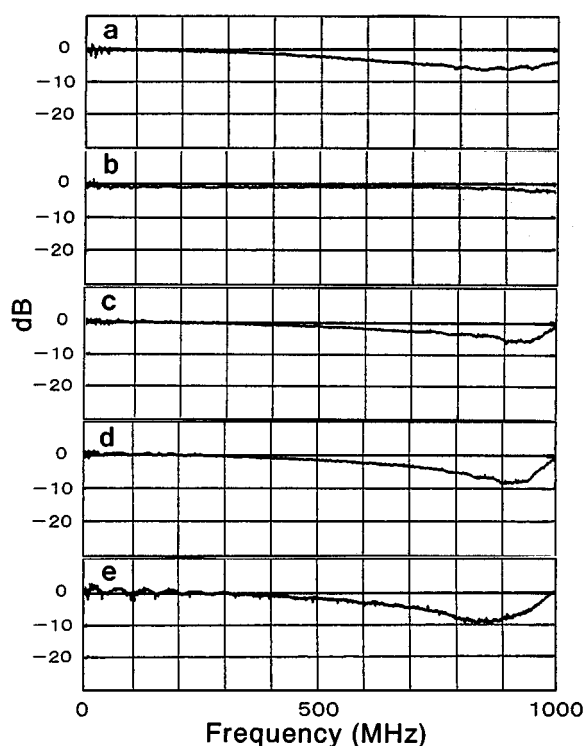

Figure 9 Attenuation ratio against the electromagnetic wave. Additive % in epoxy resin: (a, b, d) 20 wt %; (c) 10 wt %; (e) 30 wt %. Length of carbon micro-coils or TiC micro-tubes: 300  $\mu\text{m}$ ; (a) As-grown carbon micro-coils; (b) TiC powders (0.89  $\mu\text{m}$  diam.); (c, d, e) TiC micro-tubes.

#### 4. Conclusions

TiC micro-coils and micro-tubes were prepared by the vapour phase titanizing of the regular carbon micro-coils, and the preparation conditions and some properties were examined. The carbon coils were titanized from the surface of the fibers to the core with full preservation of the coiling morphology to form TiC micro-coils and micro-tubes. The bulk electrical resistivity was 0.1–0.01  $\Omega\cdot\text{cm}$  depending on the titanized rate and bulk density. The specific surface area of the source carbon coils (about 100  $\text{m}^2/\text{g}$ ) was significantly decreased with increasing reaction temperature and reaction time. The tensile strength of a TiC micro-tube was 660 MPa. The attenuation ratio of an electromagnetic wave (800–

900 MHz) of the TiC micro-coils and micro-tubes (30 wt % in epoxy resin) was about 90% ( $\text{dB} = -10$ ).

#### Acknowledgements

The authors are very grateful to Mr. N. Ueshima for his invaluable aid during the experimental program. This work was partly supported by the Grant in Aid (No. 09555200 and No. 10137101) from the Ministry of Education and Research of the Japanese Government.

#### References

1. W. R. DAVIS, R. J. SLAWSON and G. R. RIGBY, *Nature* **171** (1953) 756.
2. *Idem.*, *Trans. Brot. Ceram. Soc.* **56** (1957) 67.
3. R. T. K. BAKER, M. A. BARBER, P. S. HARRIS, F. S. FEATES and R. J. WAITE, *J. Catal.* **26** (1972) 51.
4. L. S. LOBO and D. L. TRIMM, *J. Catal.* **29** (1973) 15.
5. R. T. K. BAKER and R. J. WAITE, *ibid.* **37** (1975) 101.
6. M. HILLERT and N. LANGE, *Z. Krist.* **111** (1958) 24.
7. J. CALUSZKA and M. H. BACK, *Carbon* **22** (1984) 141.
8. M. AUDIER and M. COULON, *ibid.* **23**, (1985) 317.
9. R. A. DALLA BETTA, A. G. PIKEN and M. J. SHELEF, *J. Catal.* **40** (1975) 173.
10. A. ADDAMIANO, *J. Cryst. Growth* **58** (1982) 617.
11. T.-K. KANG, S.-D. PARK, C.-K. RHEE and II.-H. K. KUK, in Proc. 6th Japan-Korea Ceram. Seminar Kobe, 1989, p. 249.
12. S. MOTOJIMA, T. HAMAMOTO and H. IWANAGA, *J. Cryst. Growth* **158** (1996) 79.
13. S. MOTOJIMA, S. UENO, T. HATTORI and K. GOTO, *Appl. Phys. Lett.* **54** (1989) 1001.
14. S. MOTOJIMA, S. UENO, T. HATTORI and H. IWANAGA, *J. Cryst. Growth* **96** (1989) 383.
15. S. MOTOJIMA, T. YAMANA, T. ARAKI and H. IWANAGA, *J. Electrochem. Soc.* **142** (1995) 3141.
16. U. VOGT, H. HOFMANN and V. KRAMER, *Key Eng. Mater.* **89-91** (1994) 29.
17. S. MOTOJIMA, M. KAWAGUCHI, K. NOZAKI and H. IWANAGA, *Appl. Phys. Lett.* **56** (1990) 321.
18. *Idem.*, *Carbon* **29** (1991) 379.
19. S. KAWAGUCHI, I. HASEGAWA, M. KAWAGUCHI, N. NOZAKI and H. IWANAGA, *J. Chem. Vapor Deposition* **1** (1992) 136.
20. S. MOTOJIMA, I. HASEGAWA, S. KAGIYA, S. ASAKURA, M. KAWAGUCHI and H. IWANAGA, *J. de Physique* **IVC3** (1993) 599.
21. S. MOTOJIMA, M. HIRATA and H. IWANAGA, *J. Chem. Vapor Deposition* **3** (1994) 87.

22. S. MOTOJIMA, I. HASEGAWA, S. ASAKURA, K. ANDOH and H. IWANAGA, *Carbon* **33** (1995) 1167.
23. S. MOTOJIMA, Y. ITOH, S. ASAKURA and H. IWANAGA, *J. Mater. Sci.* **30** (1995) 5049.
24. S. MOTOJIMA, S. KAGIYA and H. IWANAGA, *Mater. Sci. Eng.* **B34** (1995) 47.
25. S. MOTOJIMA, S. ASAKURA, T. KASEMURA, S. TAKEUCHI and H. IWANAGA, *Carbon* **34** (1996) 289.
26. S. MOTOJIMA, S. ASAKURA, M. HIRATA and H. IWANAGA, *Mater. Sci. Eng.* **B34** (1995) L9.
27. S. MOTOJIMA, S. KAGIYA and H. IWANAGA, *J. Mater. Sci.* **31** (1996) 4641.
28. S. MOTOJIMA, H. ASANO and H. IWANAGA, *J. Euro. Ceram. Soc.* **16** (1996) 989.
29. H. IWANAGA, M. KAWAGUCHI and S. MOTOJIMA, *Jpn. J. Appl. Phys.* **32** (1993) 105.

*Received 30 December 1998  
and accepted 2 June 1999*